

DFLIFT

Make the work easier

DYC1.5-3.5 Semi-electric Stacker



Henan Dafang Heavy Machine Co., LTD

www.dflift.com

2. Technical parameters

Item	Parameters	
------	------------	--

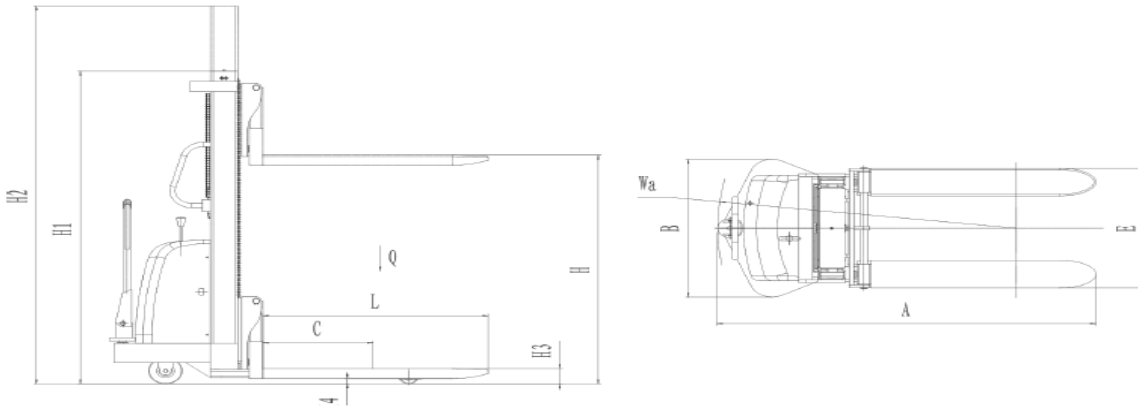



Model	Company	DYC1.5-3.5
Loading capacity	Q(kg)	3500
Load center	C(mm)	500
Lifting height	H(mm)	3500
Lowered height of Fork	H3(mm)	88
Fork length	L(mm)	1150
Fork Width	E(mm)	320~680
Turning Radius	Wa(mm)	1360
Max extend height	H2(mm)	4035
Max Lower Height	H1(mm)	2330
Overall Width	B(mm)	900
Overall Length	A(mm)	1840
Min Ground Clearance	H4(mm)	30
Channel Width	mm	2130
Lifting Speed Unladen/Laden	m/s	0.08~0.15
Lowering Speed Unladen/Laden	m/s	0.08~0.15
Lifting Motor	v/kw	12/1.5
Battery	v/ah	12V/120AH
Charger	v/a	12V/15A

Make the work easier!

Net Weight	kg	350~430
------------	----	---------

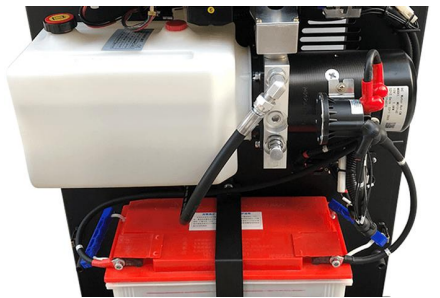
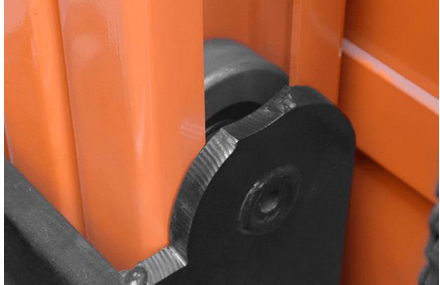
3 Product Features

Items	Configuration description
	<p>Brake system</p>
	<p>Modular design is easy to maintain</p>
	<p>No gap roller</p>
	<p>Safety partition</p>
	<p>Strengthened fork, adjustable width</p>

Make the work easier!

4. Product show



Make the work easier!

Plant: Torch Industrial High-tech Area, Xinxiang City, Henan province, China

E-mail: evan@dflift.com; Tel: 0086 373 5859155; Fax: 0086 373 5859777; WhatsApp: 0086 17337368092

Web: <https://www.dflift.com>

CERTIFICATE

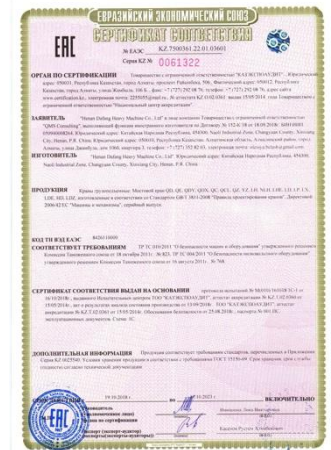

Make the work easier!